

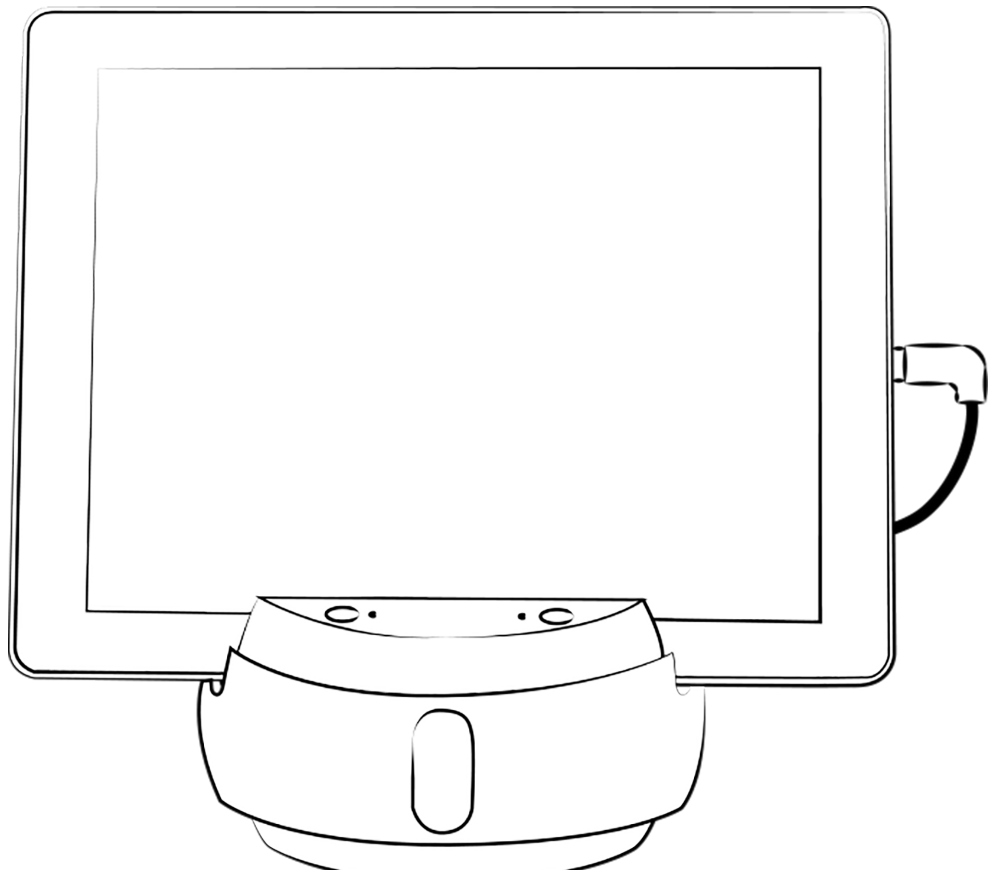

# Swivl User Guide



C Series Robot

# Swivl



Swivl Robot



Swivl App



Swivl Cloud

Swivl robot follows you with great quality audio. Now it has twice the speed of response, a simpler Lightning interface and multi-channel audio tracks so you can hear everything.

This free iOS and Android compatible app controls the firmware and settings for the Swivl Robot. The app allows users to easily record lessons or presentations.

A FERPA/COPPA compliant video reflection and skill development cloud platform for teachers and students.  
[www.cloud.swivl.com](http://www.cloud.swivl.com)

## Uses

The Swivl solution has the power to enhance teaching and learning. Some uses include:

- **Self Reflection:** Get the perspective you need to improve your practice and keep time stamped notes for future reference.
- **Peer Feedback:** Give annotated feedback to peers based on your current observational goals.
- **Presentations:** Use our Screen recording tools to capture and dialogue about events, lessons, student projects and more.
- **Flipped Class:** Upload, annotate and dialogue about any video content. Upload content from any source.
- **Video Observations:** Live or recorded. Use video for more natural and effective classroom observations with built-in rubrics.
- **Professional Learning Community:** Build a culture of collaboration with organized cohorts of teachers sharing video and dialoguing.
- **Best Practices Libraries:** Build searchable libraries of the best teaching practices in your school for everyone to learn from.

# Swivl Robot

Contents:

- Base
- Marker (docked in the base)
- USB Wall Charger
- Base Charger
- Lanyards - Wrist & Neck
- Shims (3)
- Micro USB - Lightning Cable
- Android Cable

Cables

Micro USB - Lightning (iOS)  
Micro USB - Micro USB (Android, not shown)

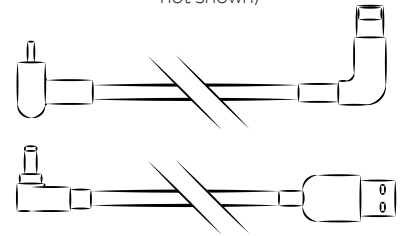

Base Charger

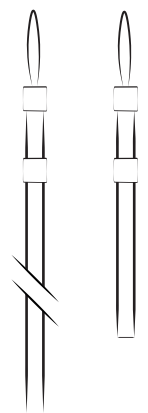
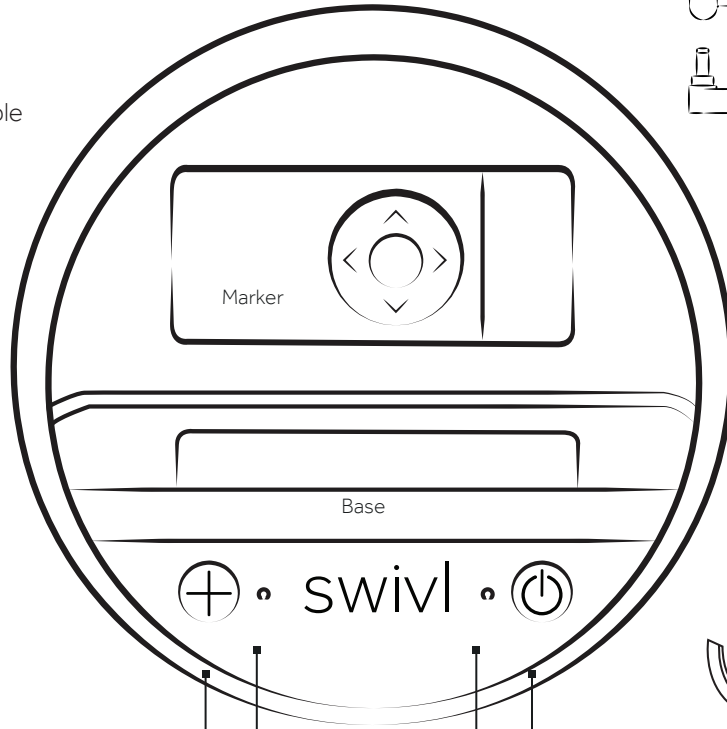

Marker Lanyards



A C D

Shims

## Key Features

Pair  
Marker status  
System status  
Power

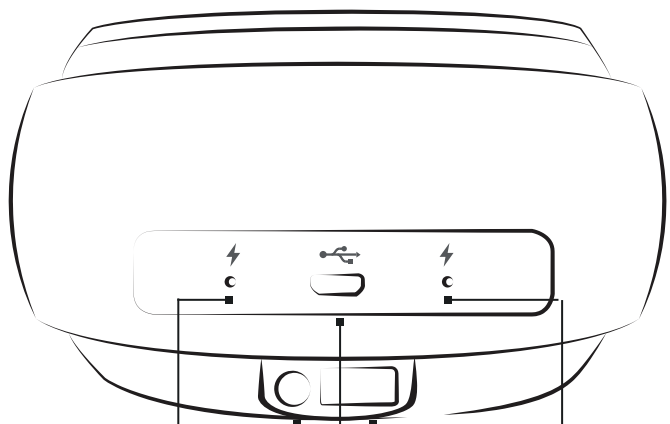

Marker Charge Status  
Power  
Expansion USB  
Base Charge Status  
Mobile Device Connection

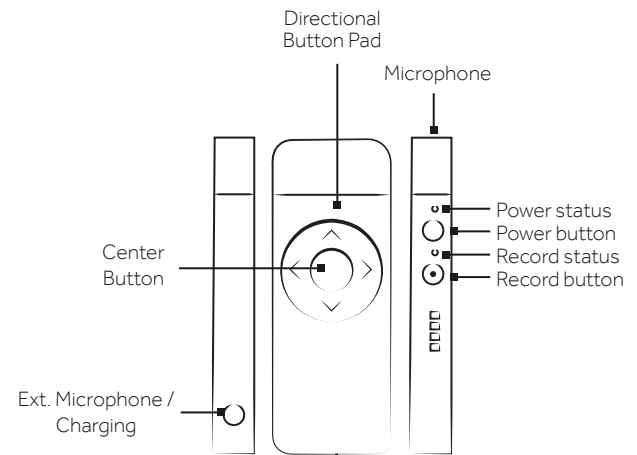

## LED Status Guide

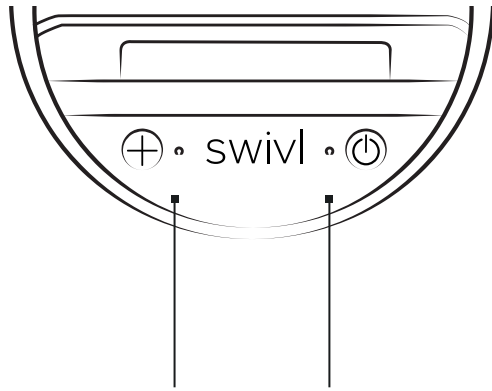

- |                                         |                                           |
|-----------------------------------------|-------------------------------------------|
| <b>Solid red</b><br>No Marker connected | <b>Solid red</b><br>No device connected   |
| <b>Flashing red</b><br>Pairing Marker   | <b>Solid green</b><br>Device connected    |
| <b>Solid green</b><br>Marker connected  | <b>(Both) Flashing Red</b><br>Battery Low |

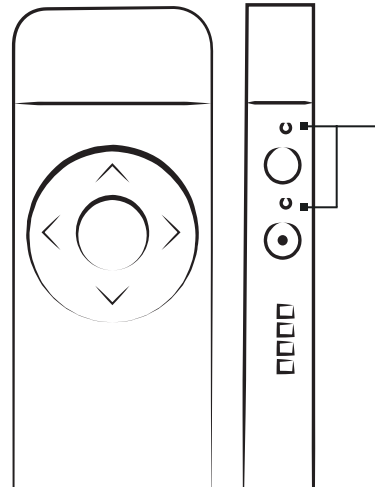

- Top: Green**  
**Bottom: Flashing Red**  
Marker looking for base
- Top: Green**  
**Bottom: Green**  
Primary Marker
- Top: Green**  
**Bottom: Off**  
Secondary Marker
- Top: Flashing Red**  
**Bottom: Flashing Red**  
Battery low

## Charging

Plug the charging cable into bottom of the base and place marker in the base dock to charge. The Charging LEDs will blink when plugged in. The battery life of the base and the marker can be checked in the Swivl app Settings. (Mobile device must be connected to the base via Swivl cable connection). The charging LEDs will indicate the charge status of the base and Marker as described in the key below. The rechargeable batteries in the base and Marker will produce about 4-6 hours of usage time.

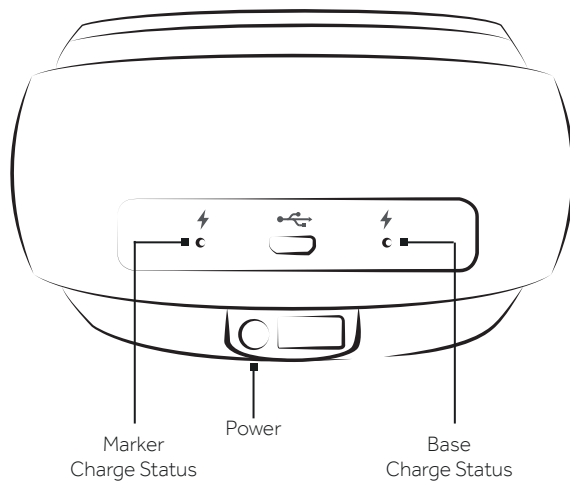

### Marker Charge Status

- Flashing Red**  
Charging, less than 40% battery
- Flashing Green**  
Charging, more than 40% battery
- Solid Green**  
Marker fully charged

### Base Charge Status

- Flashing Red**  
Charging, less than 40% battery
- Flashing Green**  
Charging, more than 40% battery
- Solid Green**  
Base fully charged

# Getting Started

## Step 1: Determine which shim best fits your device.

There are three shims that hold your mobile device. Each shim has a different thickness. Select a shim and test on edge of mobile device. Fit should be snug with no force. (For devices with large cases, a mount anything kit is available for purchase.)



First, determine which shim best fits your device.

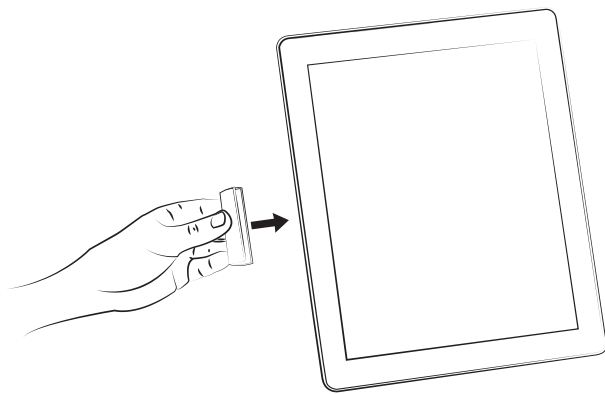

Next, push removable grip holder left and lift to remove.

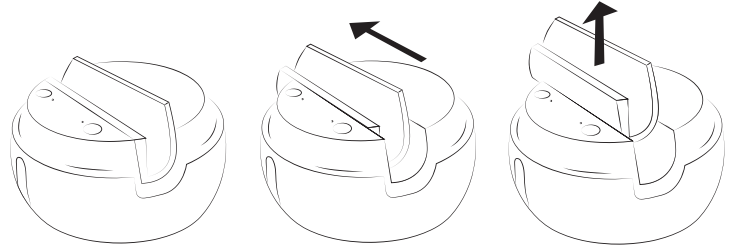

Finally, insert shim into grip holder and place in base.

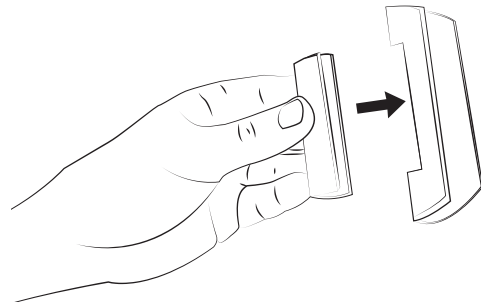

## Step 2: Power on the device.

Press and hold the Power button on the Swivl base until LEDs light-up. Remove the Marker from its dock in the back of the base. Then hold the power button on the marker for 3-4 seconds. The LEDs on the Marker will light up and the bottom LED will flash red as it searches for the base. Both lights on the Marker should turn green, indicating that it is the Primary Marker paired with this base. The Primary Marker is the one that the base will respond to and track.

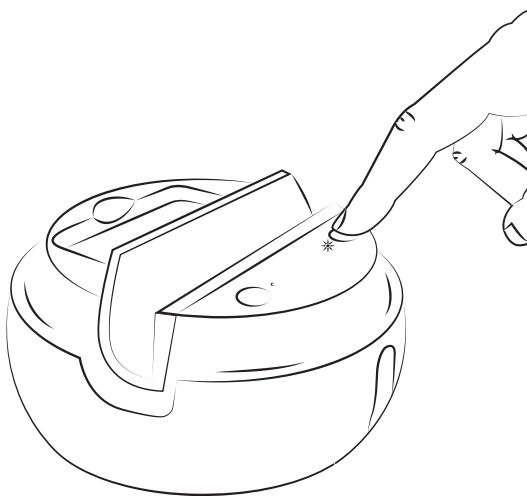

### Step 3: Connect your device.

Insert your device, screen forward into the base. Use the included Lightning cable to connect the base to your iOS device. If you are using Android, you must use a Swivl Android cable (Type C Adaptor is sold separately). When connected to a mobile device, the System Status LED next to the Power Button will turn solid green. You will be prompted to open or download the Swivl app.

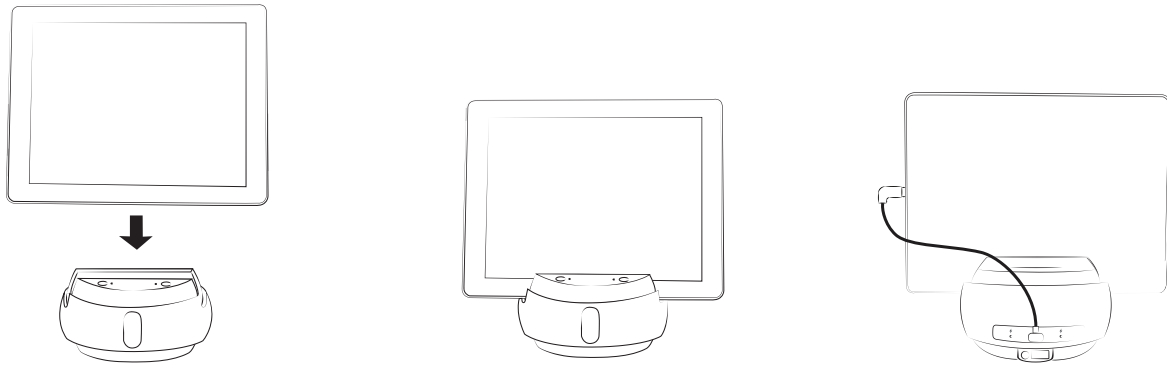

### Step 4: Pair Secondary Markers

The Swivl C Series Robot has the ability to collect audio from up to five Markers simultaneously. Aside from the Primary Marker, which comes pre-paired in the base, you may need to pair Secondary Markers to the base. You will only need to perform pairing process once.

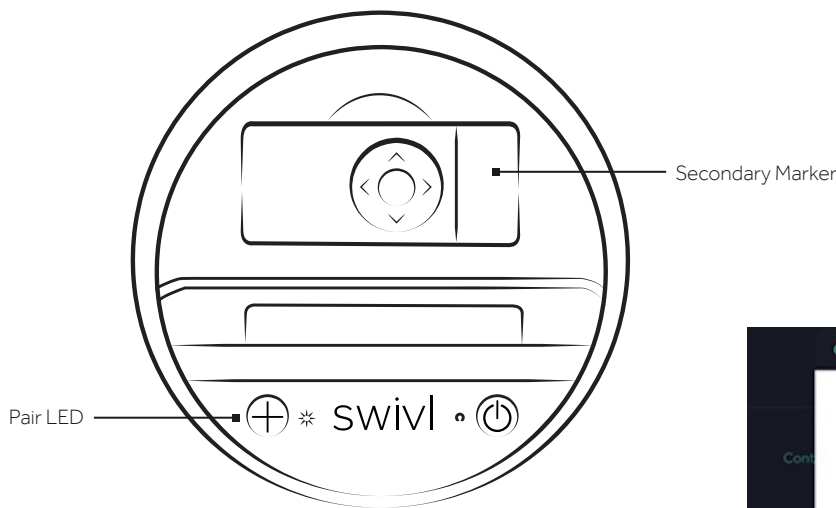

With the Swivl base on and connected to a mobile device running the Swivl app, remove packaging on the marker you wish to pair, and dock it in the Swivl base. Pair LED will blink multiple times to indicate pairing is in progress. When the Pair LED turns solid, remove the Marker from the dock and turn it on.

When you first turn on the Secondary Marker after pairing, the Swivl app will prompt you to choose a color for that Marker. When you have confirmed a color in the app, label the Marker with one of the included colored stickers. Each Marker should have a unique color label.

The color of the Marker will appear in the software to indicate which audio track was recorded from each Marker.

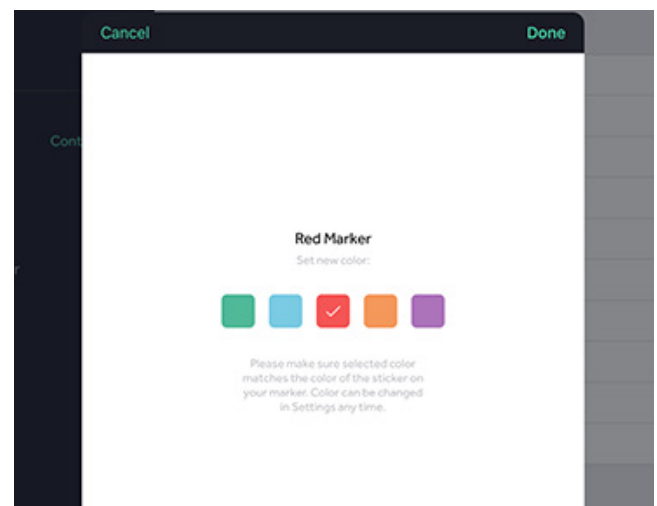

## Step 5: Select room placement.

Place Swivl approximately 5-30 feet from the presenter in the front or middle of the room. Use the Swivl floor stand for best results. The heads-up display allows the teacher to view the live recording and uploaded presentations.

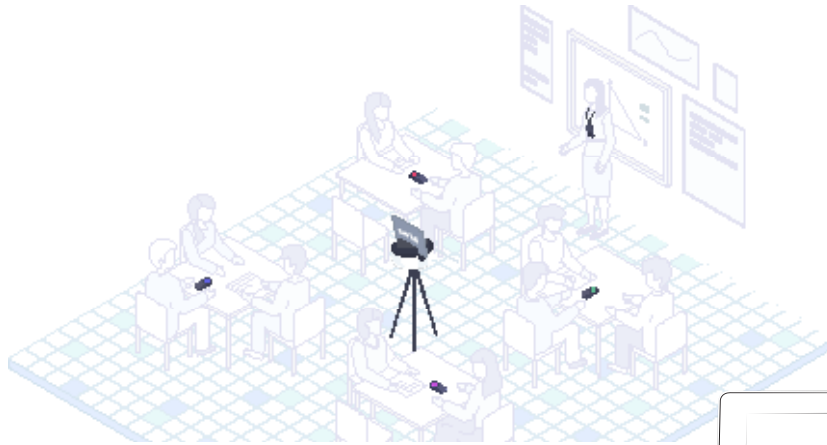

## Step 6: Capture video.

Tap the red Record Button on the side of the Primary Marker to start recording. The Record LED on the Marker will turn red and the app will begin capturing audio and video. To stop recording, tap the Record Button on the Marker again.



### Horizontal motion

Stand back at least **3 feet**. While holding the Marker or wearing it on the lanyard, walk at a normal pace across the room and the base will follow.

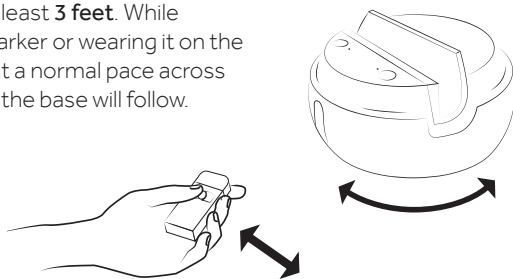

### Vertical motion

With Auto-Tilt turned on in the Swivl app settings, the Swivl will follow the up-and-down movement of the Marker.

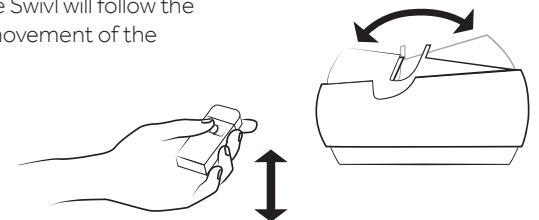

## Step 7: Share video.

Videos stored within the app take up space on your mobile device, therefore it is recommended that you upload your videos to your Swivl cloud account where they can be shared via email, URL, groups on Swivl cloud or embedded into another platform. Read on to learn more about the Swivl app and cloud.

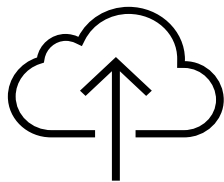

1. Within the Swivl app, upload your video to your Swivl cloud account.



2. Login at [cloud.swivl.com](http://cloud.swivl.com) to view your videos and hear the separate audio tracks from the markers.



3. You can view screen recorded presentations side by side with your Swivl video. Share with others to receive time-stamped feedback.

# Swivl App

When first opening the Swivl app you will be prompted to create a Swivl account. This will allow you to manage all of your videos on any device with an Internet browser.

When you open the Swivl app, you will have two login options:

- **Log In with Email:** Create a Swivl account using an email address and password. Use these credentials to sign into the Swivl app and cloud account.
- **Log In with Google:** Sign in using your Google credentials.

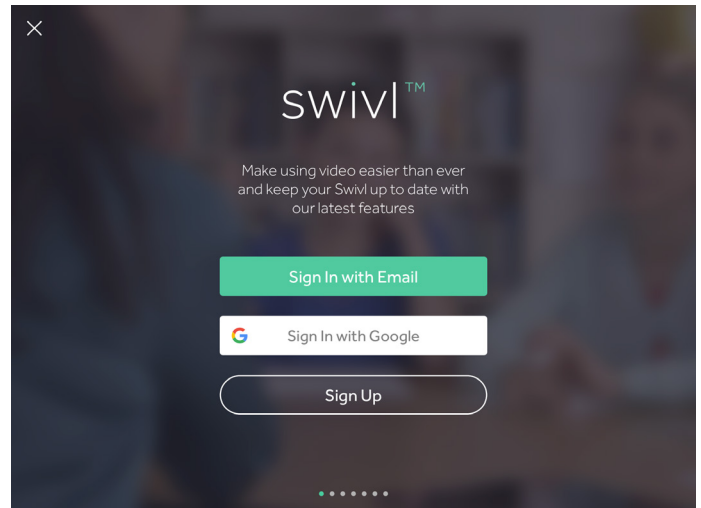

## Capture

Tap Capture in the lefthand navigation bar in the Swivl app to open the video recording screen. Here you can record video with or without a Swivl robot connected to your mobile device. The video will initially be stored on your device but can be easily uploaded to your Swivl account.

The interface of the capture screen displays certain key pieces of information, and provides the capture options below:

- **Max recording time:** (along the top) This displays the maximum recording time available. This is dependent on your device's storage space. (hours:minutes:seconds)
- **Swivl Status:** (next to max recording time) This icon will appear in white if a Swivl robot is connected, otherwise it will be red.
- **Return to Library:** Tap the 'X' to go back to the app Library or to app Settings.



The interface of the capture screen displays certain key pieces of information, and provides the capture options below:

- **Marker Menu:** This icon expands the Marker menu which displays the power status and level of audio recording from the Markers. Tap each of the Markers currently connected and adjust recording levels.
- **Record Button:** Tap to begin recording video.
- **Video/Screen Record Menu:** This icon expands the Multi-Camera and Screen Recording Session Pin. Learn more at: [Swivl.com/setup](https://swivl.com/setup).



## Settings

Tap on Settings in the navigation bar on the left of the app interface to access settings for the Swivl app and robot.

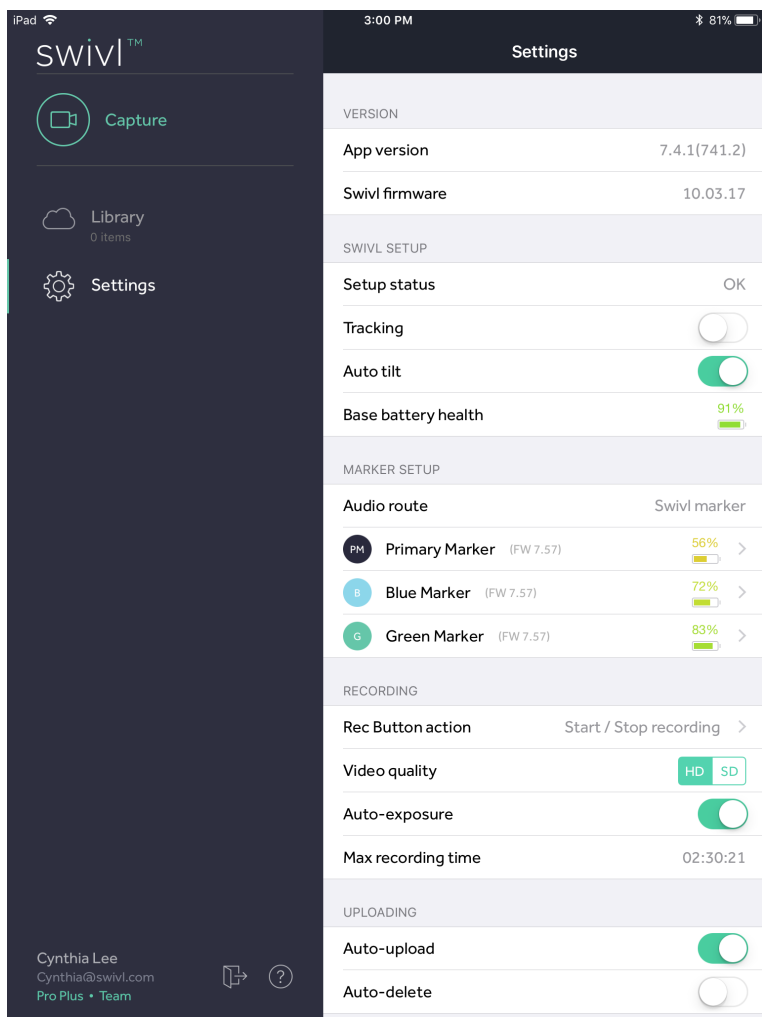

### SWIVL SETTINGS:

(Only available when connected to the Swivl base.)

- **Auto tilt:** Enable Swivl base to tilt automatically.
- **Audio route:** Indicates where audio is being captured.
- **Setup Status:** Displays the status of the device's connection with the robot.
- **Base battery health:** Indicates battery life remaining in base unit.
- **Marker Setup:** Indicates battery life remaining in marker(s) and prompts for firmware update if required.
- **Region of Swivl Usage:** This setting allows you to adjust which region you are in while using Swivl. We recommend using the Automatic option.
- **Auto microphone selection:** When enabled, this setting allows the app to select the optimal microphone to use. Recommended: Enabled.
- **Tracking:** This setting will manually disable tracking.
- **Center button action:** The checkmark action by default is set to pause tracking. It can also be set to tell the robot to do a 360° pan of the room.

### ESSENTIAL RECORDING SETTINGS:

- **Video quality:** Determine the size of video your mobile device captures. SD is recommended and requires 1.2 GB of space per 1-hour video. HD requires 2.4 GB of space per 1-hour video. It is important to note that videos are stored on your mobile device until deleted.
- **Auto-upload:** By enabling this function, your videos will automatically be uploaded to Swivl Cloud. This is recommended if you are using a wifi connection.
- **Auto-delete:** When Auto delete is enabled, as soon as a video has been fully uploaded to Swivl Cloud, it

- **Auto-exposure:** By enabling Auto-exposure, you allow the Swivl app to adapt the video capture to the lighting conditions of the capture environment.
- **Upload over cellular:** Enables upload of videos using cellular data.
- **Max recording time:** Indicates maximum amount of video (in minutes) that can be recorded on your device, based on your device's storage limitations. To enable more time for recording, keep your shared devices clear of large media files.

### VERSION:

- **App version:** Indicates which release of Swivl app is being used.
- **Swivl firmware:** Indicates which release of base firmware is being used.
- **Update firmware:** If a firmware update is available, you will be prompted to update within the app. If you decline the update, you can initiate it from the bottom of the Settings menu.

## Library

It is important to note that videos are stored in the app and consume space on your mobile device until they are deleted. It is recommended that you upload videos to Swivl Cloud and then delete them from your device when possible. If you are sharing a device with others, be sure to delete your videos and logout of the app after use.

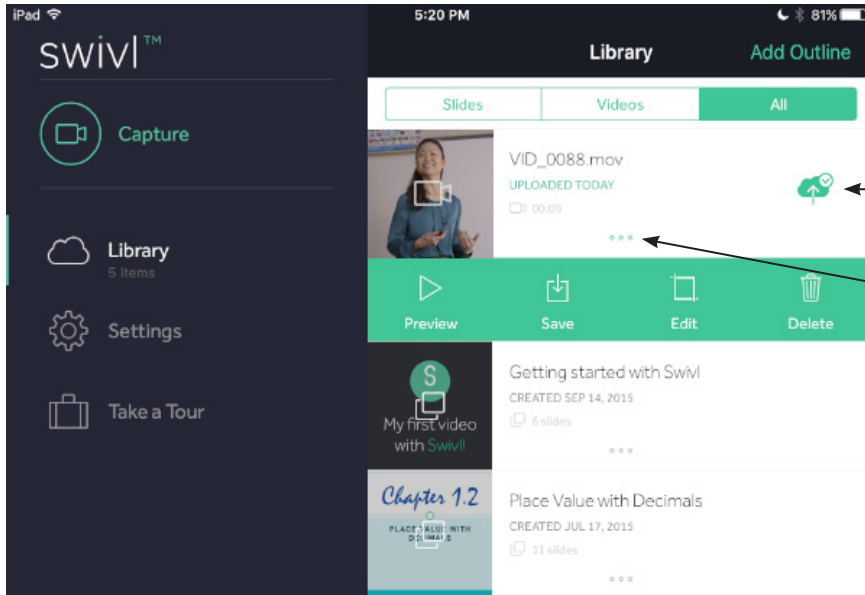

The library has three tabs at the top: Slides, Videos, All. It is within these tabs that you will see your recorded or uploaded content.

To upload videos to Swivl Cloud, click on the cloud icon.

The ellipsis will open a menu of options that include:

- **Preview:** Watch your video
- **Save:** Save your video to your device's camera roll.
- **Edit Video:** Trim the beginning or end of the video.
- **Delete:** Remove video from device.

## Uploading to Swivl

The icon to the far right of your video will let you know at what stage in the upload process your video is. The cloud icon will appear in different forms depending on whether the video has already been uploaded, is currently uploading, etc. The key below will explain the meaning of each icon.

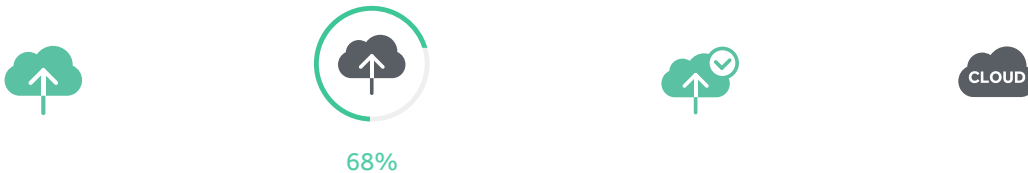

### Start Upload

- Tap to upload video to Swivl
- Video not yet stored on cloud, in device memory only
- Upload takes place over wifi connection

### Upload in Progress

- Video currently uploading to Swivl
- Tap to pause or cancel upload
- Upload time varies based on video length and wifi network strength

### Upload Complete

- Video fully uploaded to Swivl
- Video currently stored both on device and in cloud
- Delete video from app to reclaim storage space

### Uploaded, Auto-Deleted

- Video fully uploaded to Swivl
- Auto-delete has removed video from device
- You can no longer watch the video in the app

# Swivl Cloud

Login to [cloud.swivl.com](http://cloud.swivl.com) to access your videos. At the top, you will notice three tabs to the left of your initials:

- **My Feed:** Contains videos or presentations shared with you by others
- **Library:** Your videos and presentations
- **Lists and Groups:** View your created lists or groups. Groups are available for teams only. More information on Lists and Groups is available for download at: [Swivl.com/training](http://Swivl.com/training).

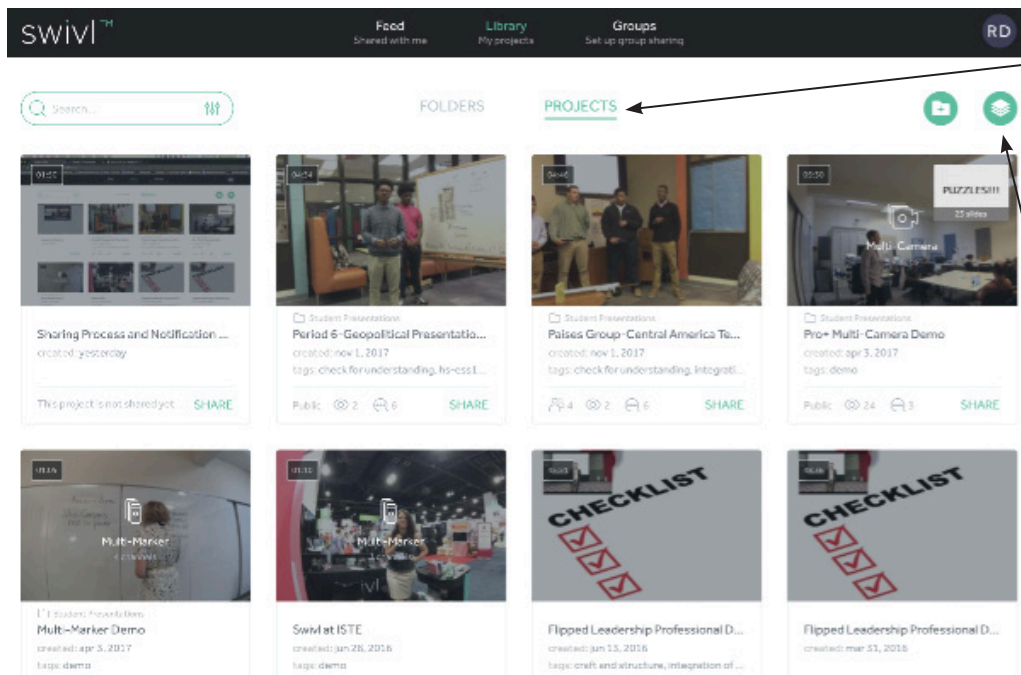

The Library contains two viewing options:

- **Projects:** See all your videos in chronological order
- **Folders:** Sort videos into private folders to keep your Library organized

**Add New Project:** While most videos are uploaded from the Swivl App, videos can be manually uploaded from other programs (MP4)

Slides may also be uploaded to use during recording. These slides may include teaching notes, discussion questions, or presentation materials.

## Sharing Projects

Projects can be shared in four different ways:

- **Direct Share:** Send email invite, requires Swivl login.\*
- **Share to List or Group:** Invite a group of users, requires Swivl login.\*
- **Share Weblink:** Create unlisted url, anyone with link can view.
- **Embed:** Embed this project on your website or blog using HTML.\*

\*Requires Pro or higher

## Exporting Projects

Video projects can be exported as an .mp4 or .mov file. When projects are exported, viewers lose the benefits of Swivl Cloud.

- **Download Project:** Save the .mp4 video file on your computer.
- **Produce:** Prepare your project (slides + video) for export and save it as a new project. There are a variety of options for combining the slides and video into a single file.
- **Export to YouTube:** Export the video file as a .mov. Only the video file is exported. If you want to export both slides and video, you should produce the video first.
- **Send a Copy:** Clone your project for another use to own.\*

\*Requires Pro or higher

## Viewing and Editing Projects

When you open a project in your Library, you have the following options to edit, produce, share or export your project.

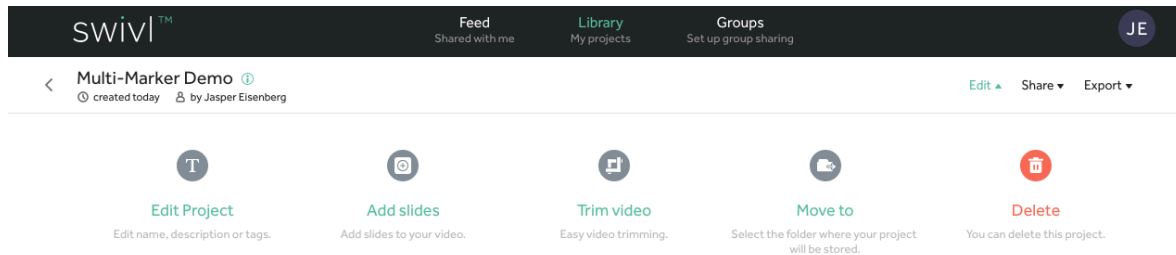

Videos without slides have the following editing options:

- **Edit Project:** Create a unique name and description for your video.
- **Add Slides:** Add slides to your video (.jpeg, .png, .ppt, .pptx, .pdf). When slides are uploaded you are able to set the time when the slides progress.
- **Trim Video:** Trim the beginning or ending of a video and save as an existing or new project.
- **Move To:** Move the project to a folder in your Library.
- **Delete:** Permanently delete the video from Swivl Cloud.

### Add slides to your video

To add slides to your video click the button below. When slides are uploaded you'll be able to set precise time when you want each slide to be displayed, as well as replace slides, change position, hide or delete.

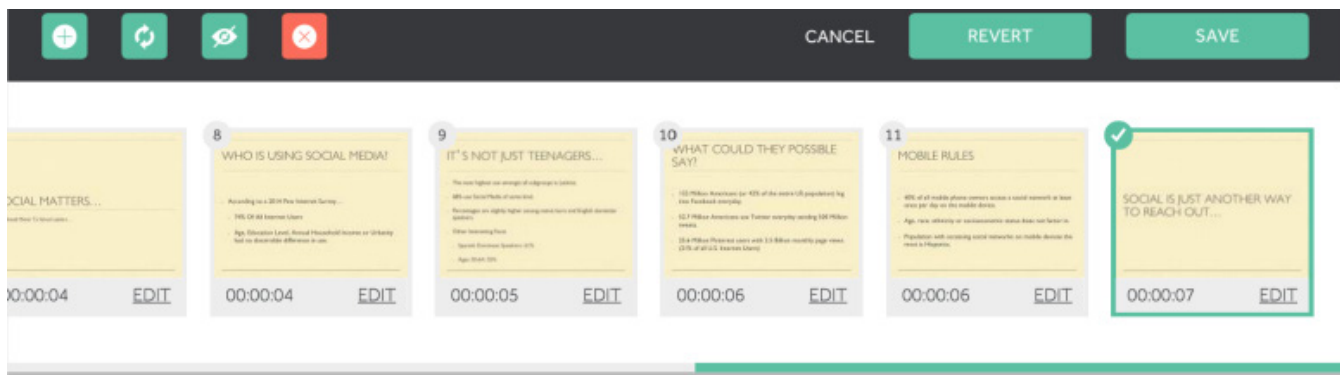

When editing slides, you have the ability to change the timing of the slides so that they are aligned to the video content. The editing functions also include the ability to:

- Upload new slide
- Replace selected slide
- Hide selected slide
- Remove selected slide

## Time-stamped Comments

When projects are shared through Swivl, viewers are able to leave feedback and pose questions using two-way time-stamped comments.

The screenshot shows a video player interface. The video content displays the text "PUZZLES!!!". On the right side of the player, there is a list of time-stamped comments:

- 00:01:37: No Movement is limited for these students in this activity due to where they are seated in class. (Category: Organizing Physical Space)
- 00:01:41: No physical proximity is important - good use of it here! (Category: Creating Environment of Trust and Risk)
- 00:05:15: (Category: Organizing Physical Space)

At the bottom of the comment list, there is a button that says "Click to leave a comment".

- Because comments are time stamped with the appropriate time from the video, users are able to dialogue and ask questions about the video.
- Commenting is great for instructional coaching feedback, self reflection and student discussion.
- Bookmark moments using the Marker up/down arrows during recording to create a placeholder timestamp. Then, during review, you can edit all of your bookmarks to write out a full comment.\*

\*Requires Pro or higher

## Analytics

When projects are shared, the owner has the ability to see viewing analytics including:

- Total visits and views
- Visits per day
- Percentage the video viewed
- Names of viewers and what percentage of the video was watched (users with a Swivl account)

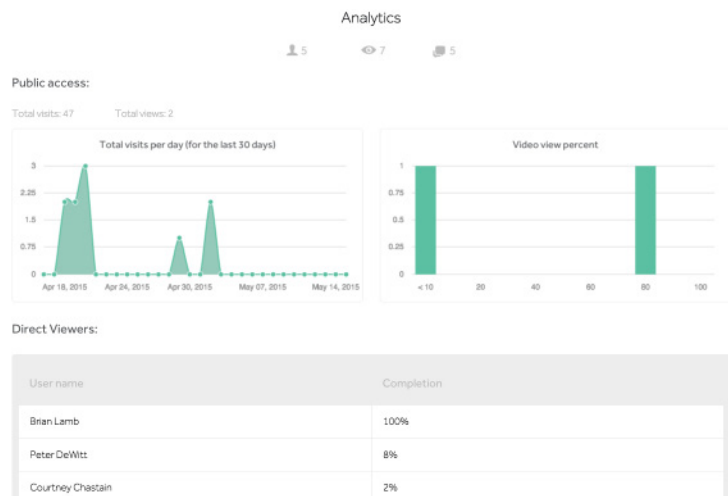

[www.swivl.com/setup](http://www.swivl.com/setup)

Support database, submit a support ticket, or leave us feedback.

ask us anything: [support@swivl.com](mailto:support@swivl.com)

**Swivl**

1450 El Camino Real | Menlo Park CA 94025 | (888) 837 6209

TM and © 2014 Swivl. All rights reserved. Swivl, the Swivl logo and all other company, product and service names or slogans are trademarks of Swivl. Patent pending.

iPad, iPhone, and iPod touch are trademarks of Apple, Inc., registered in the U.S. and other countries.

Designed in California.